

Euromaid

USER MANUAL

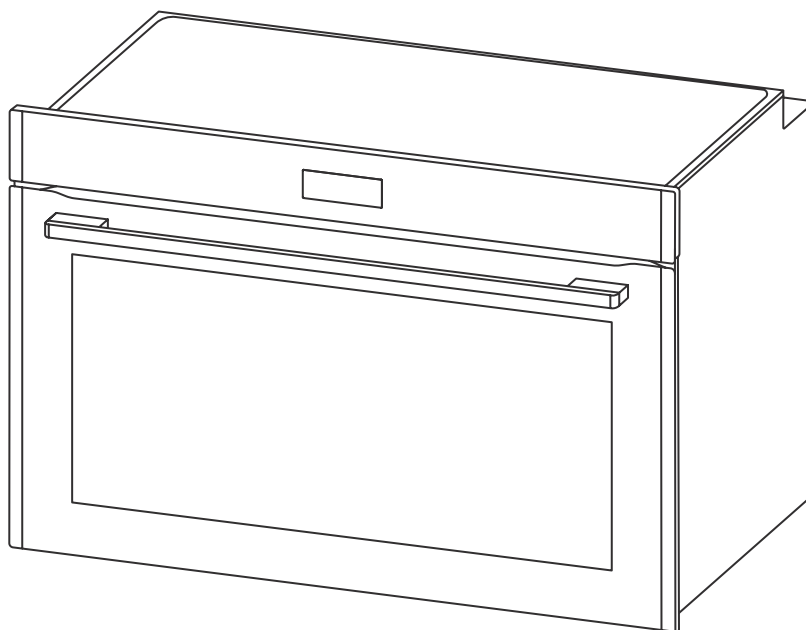

EPO917ASTB

90cm Pyrolytic Built-in Oven

PLEASE READ THE USER MANUAL CAREFULLY BEFORE USING THE UNIT

Dear Customer,

Congratulations on the purchase of your new product from **Euromaid**.

We recommend you please take some time to read the instruction manual thoroughly to familiarise yourself with the functionality and operations to ensure optimum performance of your new appliance.

After reading the manual, please store it in a safe and accessible location for future reference.

Installation

The installation of your new appliance must be carried out by a qualified installer / technician in accordance to local regulations. Please ensure all packaging materials are disposed of correctly.

Customer Care

Our Customer Care centre is available should you wish to learn more about your appliance in relation to how to use it to its best potential, or tips on cleaning as well as available accessories.

For further details please contact our Customer Care Team

Australia

Ph: 1300 556 816
customer.care.ha@glendimplex.com.au

New Zealand

Ph: 09 274 8265
nztechserv@glendimplex.co.nz



Thank you.

Regards,

Euromaid Australia and New Zealand

CONTENTS

Safety Information	4 - 7
Warnings	6
Environment Protection	7
Product Overview	8 - 14
Controls	9
Oven and Accessories	10
Cooking Modes	11
Installation	18 - 20
Cabinet Details	18
Daily Use	21 - 27
Positioning the Oven Trays & Shelves	21
Telescopic Rails	22
How to Use Your Oven	23
Safety Shutoff	23
Before You Begin	23
Operation	24
Hints & Tips	28 - 36
Cooking Advice	28
Cooking Guide	32
Cleaning & Maintenance	37 - 43
General Oven Cleaning	38
Steam Assisted Cleaning	38
Pyro / Self Cleaning	39
How to Remove the Oven Door	41
How to Dismantle the Oven Door for Cleaning	42
Replacing the Oven Lamps	43
Product Information	44
Manufacturer Guarantee	45 - 47

Icon	Type	Meaning
	Warning	Serious injury or death risk
	Caution	Injury or property damage risk
	Important / note	Operating the system correctly

SAFETY INFORMATION

We recommend that you read the instructions in this owner's manual carefully before use for the best performance and to extend the life of your appliance. It will provide you with all the information you need to ensure its safe installation, use and maintenance. Retain this owner's manual for future reference.

When handling the appliance, we recommend you always use the handles recessed into the sides of the oven to prevent personal injury or damage to the appliance.

To maintain the efficiency and safety of this appliance, we recommend that you do the following:

- Always call the Glen Dimplex service department if there are any faults with your appliance.
- Always use original spare parts available from Glen Dimplex.
- This appliance is designed for non-commercial, household use and it must not be altered in any way.

⚠ Warning! This appliance is a domestic kitchen appliance suitable for indoor installation. It is not suitable for outdoor installations such as alfresco kitchens or garages unless a qualified, competent installer has deemed the location and installation to be suitable & compliant.

- This appliance can only be used safely when it is correctly connected to an efficient earthing system in compliance with current electrical safety standards.
- If the supply cord is damaged, it must be replaced by the manufacturer or its service agent or a similarly qualified person in order to avoid a hazard.
- During use, the appliance becomes hot. Care should be taken to avoid touching heating elements inside the oven.

⚠ Warning! Accessible parts will become hot when in use.

- To avoid burns and scalds, children should be kept away.
- This appliance is not intended for use by persons (including children) with reduced physical, sensory or mental capabilities, or lack of experience and knowledge, unless they have been given supervision or instruction concerning use of the appliance by a person responsible for their safety.
- Young children should be supervised to ensure that they do not play with the appliance.
- Do not use a steam cleaner to clean the appliance.

SAFETY INFORMATION

Packaging items such as plastic bags, polystyrene, nails, etc. are potentially dangerous, and therefore appropriate measures must be taken to prevent children and the disabled from coming into contact with them.

Avoid the following:

- Touching the appliance with wet parts of the body.
- Using the appliance while barefoot.
- Improper or dangerous operation.
- Obstructing the ventilation or heat dissipation slots.
- Allowing power supply cables of other appliances to come into contact with hot parts of the oven.
- Exposing the appliance to atmospheric agents such as rain, or direct sunlight.
- Using the oven for storage purposes.
- Using flammable liquids near the appliance.

Authorised personnel must be contracted to:

- Install the appliance according to these installation instructions and any local requirements.
- Replace the temperature probe if it is damaged. The probe is part of thermostat. Only use the temperature sensing probe recommended for this oven.

Glen Dimplex Service Department must be contacted:

- If in doubt about the operation of the appliance.
- If in doubt about the soundness of the appliance after removing it from its packaging.
- If the power supply cable has been damaged or needs to be replaced.
- If the appliance requires a service.
- If you need spare parts.

SAFETY INFORMATION

Warnings

- ⚠ **Warning!** Do not steam clean the oven.
- ⚠ **Warning!** Do not use harsh abrasive cleaners or sharp metal scrapers to clean the oven door glass since they can scratch the surface, which may result in shattering of the glass.
- ⚠ **Warning!** Do not install the appliance behind a decorative door in order to avoid overheating.
- ⚠ **Warning!** Only use the appliance to cook food and nothing else.
- ⚠ **Warning!** Check that the appliance has not been damaged immediately after it has been unpacked.
- ⚠ **Warning!** Disconnect the appliance from the electrical mains if it is not functioning properly and before cleaning or performing maintenance.
- ⚠ **Warning!** When left unused for a long period, unplug the appliance from the electricity mains.
- ⚠ **Warning!** Use oven gloves to place cookware in the oven or when removing it.
- ⚠ **Warning!** Always grip the oven door handle in the centre.
- ⚠ **Warning!** Make sure the knobs are in the **off** position when the appliance is not in use.
- ⚠ **Warning!** Glen Dimplex will not accept any liability as a result of any damage due to incorrect installation or improper use.

SAFETY INFORMATION

Environment Protection

The appliance shall not be discarded together with the urban refuse and rubbish. The materials used on this appliance marked by the symbol  are recyclable.



The symbol on the product or on its packaging indicates that this product may not be treated as household waste. Instead it should be taken to the appropriate collection point for the recycling of electrical and electronic equipment. By ensuring this product is disposed of correctly, you will help prevent potential negative consequences for the environment and human health, which could otherwise be caused by inappropriate waste handling of this product. For more details information about recycling of this product, please contact your local council, your household waste disposal service or the shop where you purchased the product.

Packaging Materials

The materials with the symbol are recyclable.

Dispose the packaging in a suitable collection containers to recycle it.

PRODUCT OVERVIEW

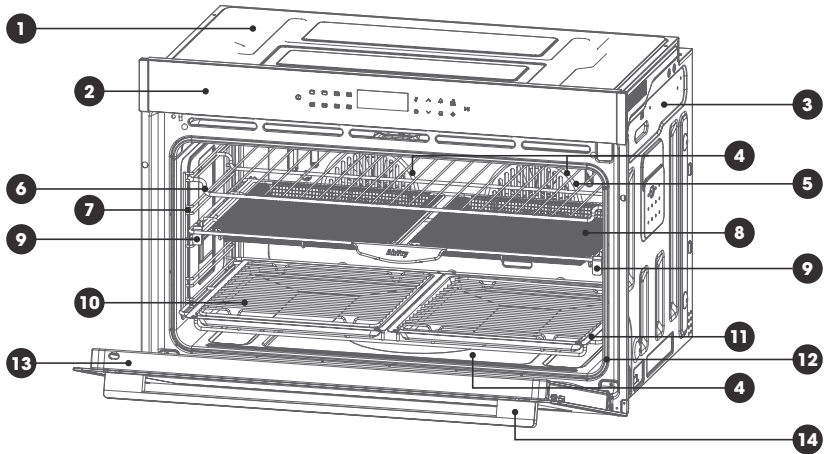

① Top panel	⑧ 2x air fry baskets and holder
② Control panel	⑨ Telescopic rails
③ Side panel	⑩ Grill insert
④ Element	⑪ 2x baking trays and holder
⑤ Fan and element cover	⑫ Door seal
⑥ Chrome wire shelf	⑬ Oven door
⑦ Side racks	⑭ Oven door handle

① **Note:** Above picture is for reference only. The actual appliance may be slightly different.

PRODUCT OVERVIEW

Controls

- ① Left hand side controls
- ② Time, temperature and function display
- ③ Right hand side controls

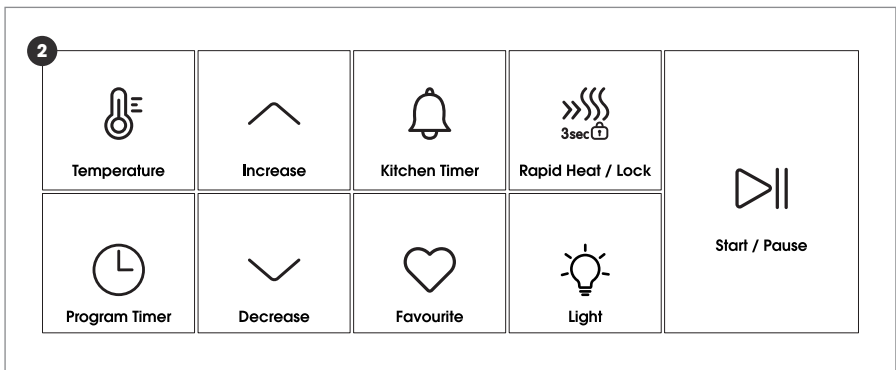
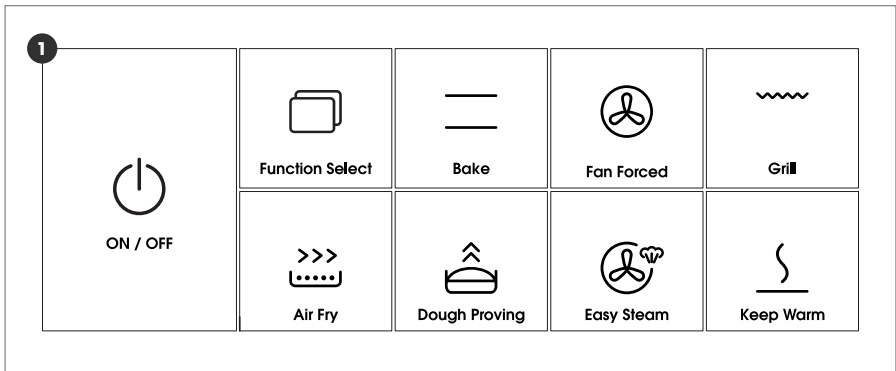
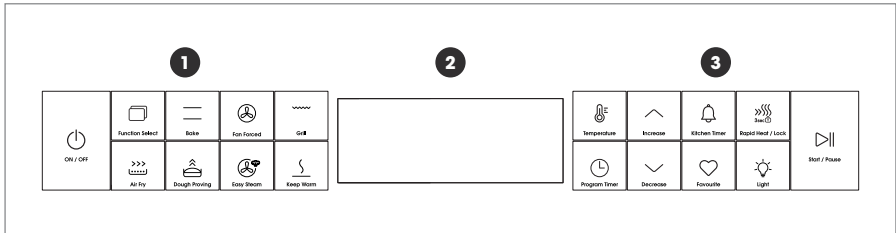

PRODUCT OVERVIEW

Oven and Accessories

There are five shelf positions in the oven. The oven is supplied with:

- ① 2x chrome wire shelf supports
- ② 2x split baking trays
- ③ 1x baking tray holder
- ④ 2x grill inserts
- ⑤ 2x Air Fry baskets + 1x holder
- ⑥ 1x set telescopic rails

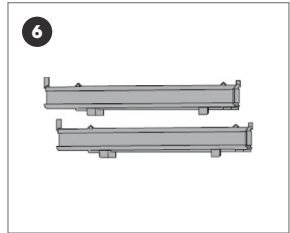
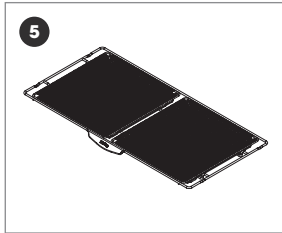
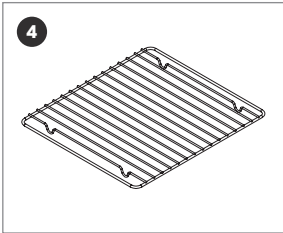
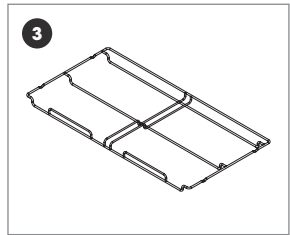
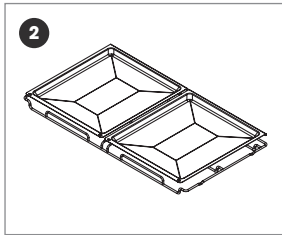
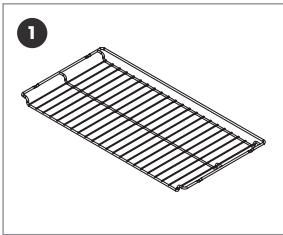

Shelf positions / levels

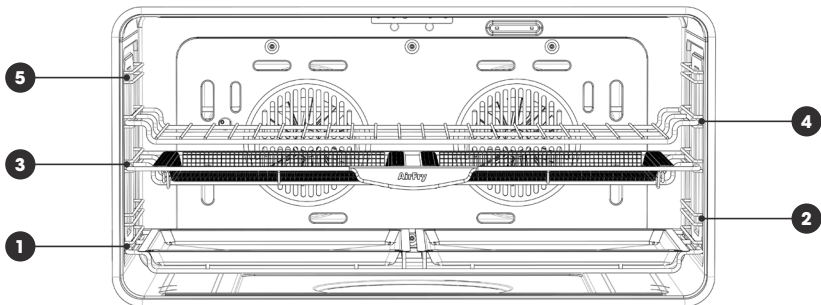

PRODUCT OVERVIEW

Cooking Modes



Grill

Directs radiant heat from the powerful upper element onto the food. The **grill** function is best suited for cooking different cuts of meat such as steak, chops, sausages and fish, or for making toasted sandwiches and other quick-cooking foods. For the best results, allow the grill to preheat for 3 minutes before placing food inside. This will help to seal in the natural juices and maintain tenderness of meats. **Always grill with the oven door closed.**

Preset temp.	Preset cooking time*	Temp. range	Max. cooking time*
180°C	0:30	80 - 230°C	23:59



Maxi Grill

Directs radiant heat from the 2 powerful upper elements onto the food.

Maxi grill allows you to use the full size of the grill tray for cooking larger meals, and will cook faster than the **grill** function.

Maxi grill is best suited for cooking different cuts of meat such as steak, chops, sausages and fish, or for making toasted sandwiches and other quick-cooking foods. For the best results, allow the grill to preheat for 3 minutes before placing food inside. This will help to seal in the natural juices and maintain tenderness of meats. **Always use maxi grill with the oven door closed.**

Preset temp.	Preset cooking time*	Temp. range	Max. cooking time*
200°C	0:30	80 - 230°C	23:59

**Preset cooking times & maximum cooking times in hh:mm*

PRODUCT OVERVIEW



Fan Grill

Generates heat from the upper element which is circulated throughout the cavity by the fan. This combination helps to distribute the heat more evenly onto the food, which helps to avoid burning or overcooking. The **fan grill** function is ideal for larger cuts of meat which require longer cooking times and will achieve results similar to **roisserie** cooked meat. **Use the fan grill function with the oven door closed.**

Preset temp.	Preset cooking time*	Temp. range	Max. cooking time*
180°C	1:00	80 - 230°C	23:59



Bake

The oven is heated using two elements, one located at the top of the cavity and the other below the floor of the oven. This traditional baking function achieves the best results when cooking on a single oven shelf, to ensure even heat distribution to the food. It is ideal for cooking single trays of biscuits, muffins, cakes and roasts.

Preset temp.	Preset cooking time*	Temp. range	Max. cooking time*
170°C	1:00	30 - 260°C	23:59



Fan Assist

The oven is heated using two elements, one located at the top of the cavity and the other below the floor of the oven. The fan circulates the hot air around the cavity for better heat distribution, allowing you to place food in different positions in the oven to cook at the same time. It is suggested to use a maximum of two shelves with the **fan assist** function and avoid using the bottom shelf to prevent overcooking the base. Food placed on the upper shelf will cook more quickly than the lower shelf.

Preset temp.	Preset cooking time*	Temp. range	Max. cooking time*
200°C	1:00	30 - 260°C	23:59

**Preset cooking times & maximum cooking times in hh:mm*

PRODUCT OVERVIEW



Fan Forced

Uses the rear element surrounding the fan to generate heat. The fan then circulates the hot air to maintain a consistent temperature throughout the oven cavity. This allows you to cook food in different areas of the oven at the same time. **Fan forced** is a very versatile cooking function which can be used for most types of cooking and baking, and will cook foods faster and at a lower temperature than standard **bake** functions.

Preset temp.	Preset cooking time*	Temp. range	Max. cooking time*
160°C	1:00	30 - 260°C	23:59



Eco Bake

Is an energy saving baking mode. Like the 'Fan Forced' function, the rear element and fan distribute heat evenly throughout the oven. The heating element cycles on and off in stages to use less power, while the residual heat inside the oven cooks the food more efficiently.

Preset temp.	Preset cooking time*	Temp. range	Max. cooking time*
160°C	0:30	40 - 230°C	23:59



Roast

Is a unique cooking function which uses heat from all cooking elements as well as the fan to surround the food and lock in flavour. This function ensures food is cooked evenly throughout with excellent browning, which makes it perfect for roasting meats or baking lasagne.

Preset temp.	Preset cooking time*	Temp. range	Max. cooking time*
170°C	1:00	30 - 260°C	23:59

**Preset cooking times & maximum cooking times in hh:mm*

PRODUCT OVERVIEW



Pizza

Combines the fan forced function with the lower element, to create an ideal setting for cooking pizza's, tarts and quiches. The fan element and fan distribute the hot air to cook food thoroughly and melt the toppings, while the lower element helps to crisp the base. For the best pizza results, pre-heat a pizza stone or baking tray for 1 hour before placing food inside.

Preset temp.	Preset cooking time*	Temp. range	Max. cooking time*
170°C	1:00	30 - 260°C	23:59



Air Fry

Delivers the benefits of a bench top Air Fryer into your built-in oven. This premium function generates heat from the powerful upper and fan elements, which is circulated by the fan to rapidly heat the oven cavity. The hot air ensures food is cooked quickly and thoroughly without having to turn it, while the radiant heat from the upper element helps to achieve the crispiest results. The **Air Fry** function combined with the Euromaid Air Fry basket are ideal for oven frying your favourite frozen foods such as chips, wedges or chicken nuggets without any oil.

Preset temp.	Preset cooking time*	Temp. range	Max. cooking time*
230°C	0:22	150 - 230°C	23:59



Defrost

Uses the fan to circulate room temperature air around the cavity. This function helps to defrost (thaw) different kinds of food before cooking. Using the **defrost** function will reduce defrosting times by up to 50%.

Preset temp.	Preset cooking time*	Temp. range	Max. cooking time*
40°C	0:30	40 - 60°C	23:59

**Preset cooking times & maximum cooking times in hh:mm*

PRODUCT OVERVIEW



Dough Proving

Gentle heat is generated from the upper and lower elements, to provide an ideal warm and draft-free environment for proving dough. This function helps to proof more quickly than at room temperature.

Preset temp.	Preset cooking time*	Temp. range	Max. cooking time*
35°C	0:20	30 - 50°C	23:59

- ① To prove dough, place the dough in a lightly oiled bowl and cover with a clean damp cloth or plastic wrap.
 - ② Position the bowl in the centre of the oven. Select the **dough proving** mode and touch the start / pause button  to begin. It is best to check the dough every 30 minutes to avoid over proofing.
- ① **Note:** Dough proving mode is not a cooking function.



Keep Warm

Uses gentle heat from the lower element to provide a consistent low temperature between 30 - 70 degrees. This function can be used to keep hot food warm before or after serving, or to warm plates and serving dishes.

Preset temp.	Preset cooking time*	Temp. range	Max. cooking time*
70°C	0:30	30 - 70°C	23:59

- ① **Note:** Keep warm mode is not a cooking function.



Light

Turns on only the oven light, the light remains on when the oven is operating.

**Preset cooking times & maximum cooking times in hh:mm*

PRODUCT OVERVIEW







Easy Steam / Steam assisted cooking

Cooking with steam is a great addition to regular **hot air** or **fan forced** cooking functions. Steam helps to bring out the natural flavours of food, cooking it more evenly and retaining more nutrients and goodness. Steam assisting cooking functions, such as Euromaid easy steam, consistently produce juicy, succulent interiors with crispy, golden finishes.



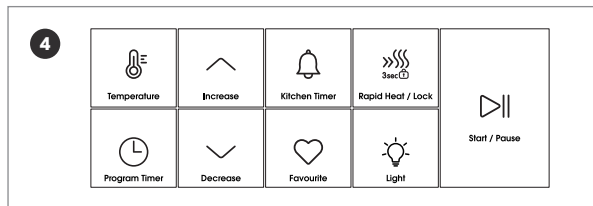
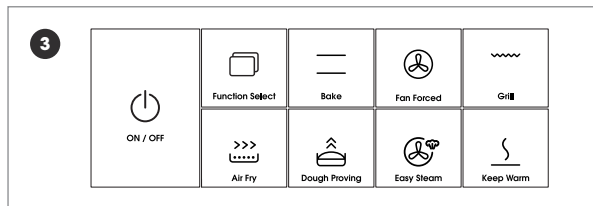
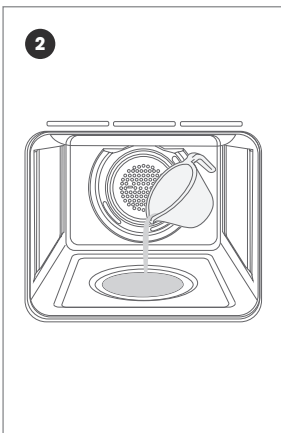

- ⚠ **Warning!** Risk of burns or damage to the appliance.
- ⚠ **Warning!** Do not open the oven door when the Easy Steam function is in operation, except when preheating.
- ⚠ **Warning!** Open the oven door carefully once the steam function has completed.

How to use

- ① Open the oven door.
- ② Add 150ml of water to the well on the base of the cavity while oven is cold.
- ③ Select **easy steam**  on the function menu.
- ④ The pre-set temperature for easy steam is 160°C. To change the temperature, press the temperature button  and then use the  or  buttons to adjust the temperature up or down.



PRODUCT OVERVIEW

- ⑤ The pre-set cooking duration is 1:00hr. To change the time, press the program timer button  and then use the  or  buttons to adjust the time up or down.
- ⑥ Once the settings have been selected, press the start / pause button  to start the program.
- ⑦ Pre heat for 10 minutes or until the oven has reached the set temperature.
- ⑧ Place food into the oven and cook as per recipe suggestions.

⚠ Caution! Do not refill cavity well with water during cooking or while oven is hot.

- ⑨ To turn the oven off, press the on / off button .

⑩ **Note:** The oven will automatically switch off once the timer has ended.

- ⑩ Once the oven is cool, wipe away any excess water from the cavity well.

INSTALLATION

- ① **Important!** Installation, assembly and electrical connections must be carried out by authorised personnel.

Cabinet Details

In order to ensure that the built-in appliance functions properly, the cabinet containing it must be appropriate. The figure below gives the dimensions of the cut-out for installation under the counter or in a wall cabinet unit.

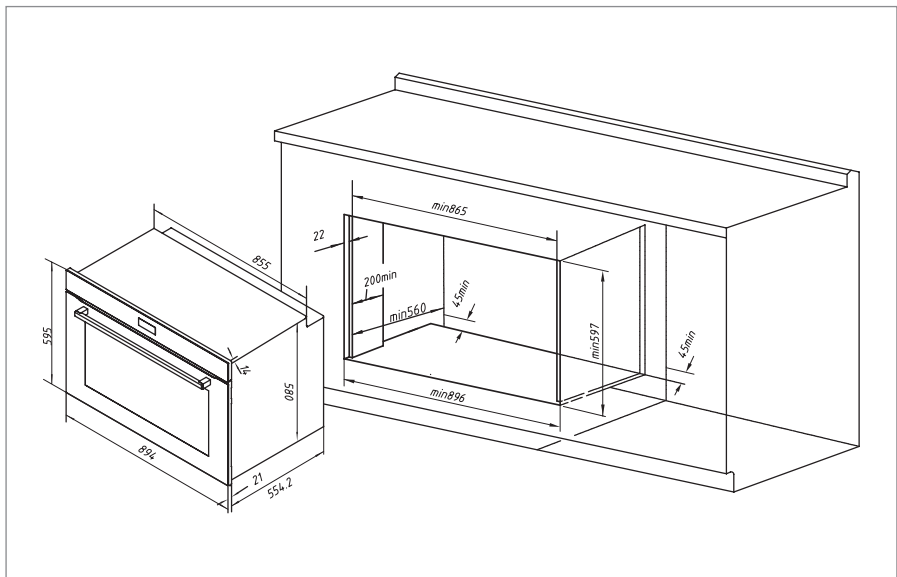
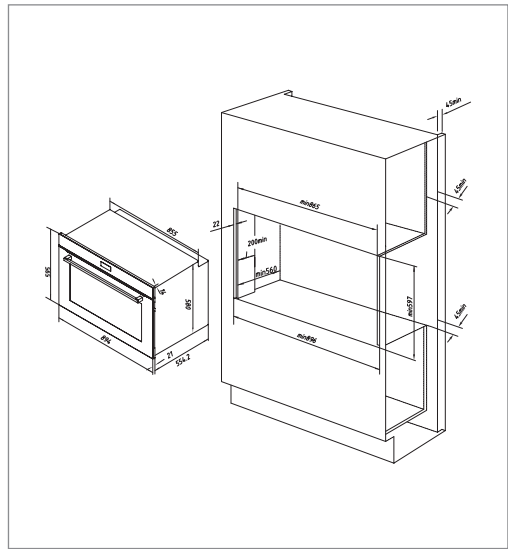

INSTALLATION

The panels of the adjacent cabinets must be made of heat resistant material. In particular, cabinets with a veneer exterior must be assembled with glues which can withstand temperatures of up to 75°C.

In compliance with current safety standards, contact with the electrical parts of the oven must not be possible once it has been installed.

All parts, which ensure the safe operation of the appliance, must be removable only with the aid of a tool.

To fasten the oven to the cabinet, open the door of the oven and attach it by inserting the 2 wood screws into the 2 holes located on the perimeter of the frame.

Electrical connection

- The appliance is usually supplied fitted with a power cord and 3 pin plug. Install the cooker so that the plug is easily accessible. Plug the 3-pin plug into a properly earthed, 15A general purpose power outlet preferably on a separate dedicated circuit. The supply cable should be positioned so that it does not reach a temperature of more than 75°C along its entire length.
- If the appliance is not supplied with a plug or if connecting the cable directly to the mains, connection to the electricity supply must be made by an authorised person in accordance with the Wiring Rules AS/NZS3000. The installation must include a suitable isolating switch with a minimum contact opening of 3mm between the appliance and the mains. The isolating switch should be sized according to the load on the data label and should comply with current regulations (the earth wire should not be interrupted by the circuit breaker).

INSTALLATION

Before making the connection

- Check that the switch, wiring and electrical system can support the appliance load (see data plate);
- Check the power supply system has an efficient earthing connection which complies with the provisions of current regulations;
- Check the power outlet or omnipoar circuit-breaker is easily accessible once the cooker has been installed.

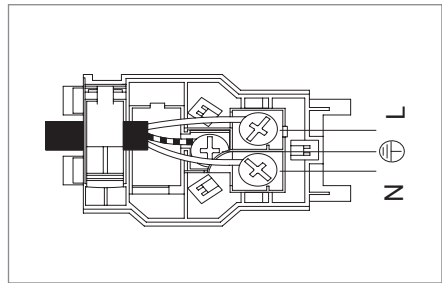
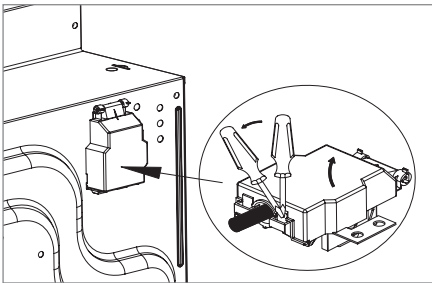

Replacing the power supply lead

- If the supply cord or plug is damaged, it must be replaced by the manufacturer or its service agent or a similarly qualified person in order to avoid hazard.

⚠ Warning! All electrical connections must be made by a suitably qualified and licenced person in accordance with local regulations. Glen Dimplex will not be held responsible for damages caused to cabinetry due to incorrect installation.

DAILY USE

Positioning the Oven Trays & Shelves

- The Grill Tray or Oven Shelf can be located in any of the five height positions in the oven. Refer to the **cooking guide table** for the recommended shelf position. When fitting the trays or shelves, ensure they are fitted between the two wires that are closest together as shown below.
 - Oven Shelves have a stop so that they are not fully withdrawn by accident. To fully remove the oven shelves, lift the front of the shelf slightly and withdraw fully from the oven.
- ① **Note:** that the Baking Tray does not have a stop position and can be fully withdrawn without interruption, so be careful not to accidentally fully withdraw the tray.
- Fit trays and shelves between bars as shown below.
 - To remove the oven side racks, push the wire support backwards towards the rear of the oven cavity to release from the locking pin. Once released, the side racks can be removed by gently pulling out of the positioning holes in the oven walls, towards the centre of the oven. To replace the side racks, repeat steps in reverse procedure.

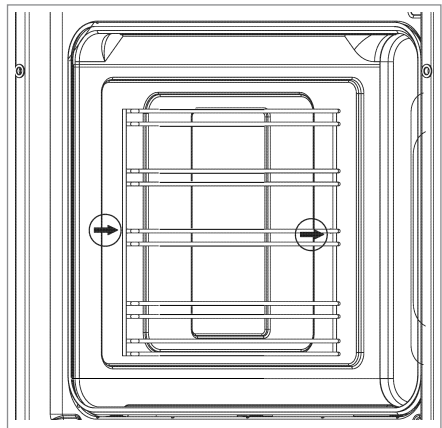
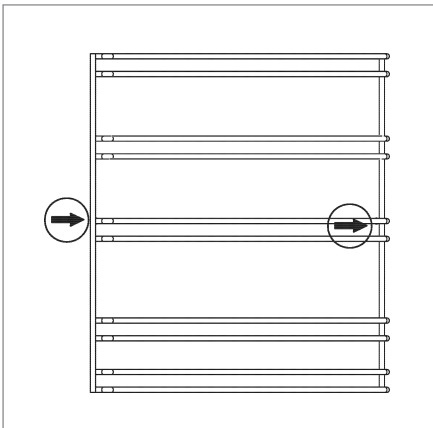

DAILY USE

Telescopic Rails

This oven includes a set of fully-extending telescopic rails which can be positioned on different shelf levels, allowing the ovens racks, trays and Air Fry basket to slide in and out effortlessly.

- ① To un-clip the telescopic rail for cleaning or repositioning purposes you must apply outward pressure on the underside of the telescopic rail to release. (Note: reverse of rail shown).
- ② To re-fit the telescopic rail, locate the clip into the top rail on the shelf guide and push downward, the rail will clip into place.
- ③ The telescopic rail is designed to support either a shelf or grill / baking tray and can be installed on any of the shelf positions.

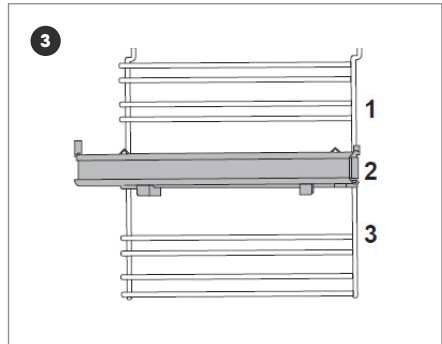
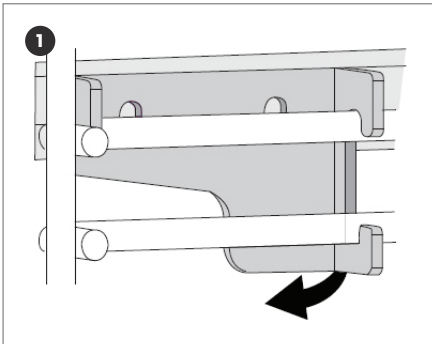

DAILY USE

How to Use Your Oven

This multi-function oven combines the advantages of traditional conventional ovens with those of the more modern fan assisted models in a single appliance.

It is an extremely versatile appliance that allows you to choose easily and safely between different cooking modes.





Safety Shutoff

This oven's electrical circuitry features a thermal shutoff system. If the oven heats to abnormally high temperatures, the system will shut off the power supply to the heating elements for a period of time until the oven cools down to a safe temperature.

- ① **Note:** The oven comes with a soft close door feature which will only operate correctly when sufficient initial force is applied when closing. Should insufficient force be applied, the door may need to be closed manually.

Before You Begin

Setting the clock

- When power is first supplied to the oven, the display on the control panel will light briefly and **12:00** will appear in the display.
 - The clock can only be set with the oven in standby mode.
- ① **12:00** will appear in the display when power is first supplied to the appliance.
 - ② Touch the program timer button , **12:00** will blink on the display.
 - ③ Use the  or  buttons to set the time.
 - ④ Touch program timer button  again to save the settings.

DAILY USE

Operation

Switching the oven on / off





To switch the oven on or off, touch the on / off button . When the oven is switched on, it will enter standby mode until a function has been selected.

Switching the light on / off



To switch the light on / off, touch the light button .

The light will also switch on when any oven function is running.

Setting the oven function

- ① After the clock is set, touch the button of the desired cooking function on the control panel or, touch the function select button  and then use the  or  button to select the desired function.
 - ② If you are happy with the preset temperature and cooking time, touch the start / pause button  to begin cooking.
 - ③ To change the temperature or cooking time, please see the following instructions.
- ① **Note:** Each function has a preset temperature and cooking time which will be displayed on the control panel once a function has been selected. (See section on **oven functions**)







Setting the oven temperature

- ① After the function is selected, touch the temperature button  to enter the temperature settings.
- ② Touch / touch and hold  or  buttons to adjust the temperature up or down.

DAILY USE





Setting the cook time

You can also set the cook time during cooking.

- ① Touch the program timer button , the cook time icon  will appear on the display and begin to flash.
- ② Touch  or  button to set the desired cook time.
- ③ Touch the program timer button  again and the end time icon on the display begins to flash. Touch the program timer button  again to skip the end time or follow steps 2 and 3 below to set the end time.









Setting the end time

You can also set the end time during cooking.

- ① Touch the program timer button  several times until the end time icon  will appear on the display and begin to flash.
- ② Touch  or  button to set the desired end time.
- ③ Touch the program timer button  again or wait for about 3 seconds and the new end time will be set.
- ④ When the cooking time has ended **END** will show on the display and the oven will beep 5 times.





Delayed start / automatic cooking

If the end time is entered after the cook time has already been set, the cook time and the end time are calculated and if necessary the oven sets a delayed start point. This can be used for automatic cooking where the oven will start and end at the chosen time.



- ① Turn the oven on and select a function as above.
- ② Touch the program timer button , the cook time icon  on the display will begin to flash. **Example:** current time is 3:00 and the desired cook time is 1 hour.
- ③ Touch  or  button to set the desired cook time (1:00).
- ④ Touch the program timer button  again, the end time icon  on the display will begin to flash. **Example:** you want to cook for 1 hour and finish at 8:30.
- ⑤ Touch  or  button to set the desired end time (8:30)
- ⑥ Touch the program timer button  again. The oven will be inoperative until the delayed start point. **Example:** the oven will turn on at 7:30, cook for 1 hour and turn off at 8:30.

DAILY USE

Kitchen timer



- ① Touch the kitchen timer button  and the bell icon  on the display begins to flash.
- ② Touch  or  button to set the desired time.
- ③ Touch the kitchen timer button  to start the kitchen timer. When the set time has elapsed, an audible signal sounds.

Child safety function

- ① Touch and hold the rapid heat / lock button  for 3 seconds. The lock icon will appear in the display.
- ② Touch and hold the rapid heat / lock button  for 3 seconds again to unlock.





Rapid heating (preheating)

With the use of the rapid heat / lock function , the empty oven can be preheated in a short time.

- ① **Important!** Before the completion of the rapid heat / lock function , do not put food into the oven for baking.
- ① Set the desired oven function and temperature for cooking.
- ② Touch the rapid heat / lock button . An audible signal sounds. When the temperature is reached, an audible signal sounds for about 2 seconds. The oven then returns to the set cooking function and temperature. The food can now be placed into the oven.

DAILY USE

Favourite mode

- ① When the function has ended and **END** is displayed, the current cooking mode can be stored by touching and holding the favourite button  without touching any other button. A total of 4 cooking modes can be stored. When more than 4 modes are stored, the earliest cooking mode will be replaced.
- ② In stand-by mode (oven turned on but no function selected), touch the favourite button , the screen will display the cooking modes that have been stored,
- ③ Touch  or  button or to select the desired cooking mode and press the start / pause button  to begin cooking in the chosen mode.

The oven light

- To switch the light on / off, touch the light button .
The oven light remains on when the oven is operating.

Cooling ventilation

- In order to cool down the exterior of the appliance, this model is equipped with a cooling fan, which switches on automatically.
 - When the cooling fan is on, you will notice a flow of air exiting between the oven door and the control panel.
- ① **Note:** When cooking is finished, the cooling fan continues to operate until the oven cools down and then switches off automatically.

HINTS & TIPS



Cooking Advice

The oven offers a range of settings which allow you to cook any type of food in the best possible way. With time you will learn to make the best use of this versatile cooking appliance and the following directions are only a guideline which may be varied according to your own personal experience.

Preheating

- See section on **rapid heating** on page 26.

Multi shelf cooking

If you have to cook food using several racks, use either the **fan forced mode**  or the **roast mode** .



When cooking delicate food on more than one rack, use the **fan forced mode** , which allows you to cook on 3 racks at the same time (the 1st 3rd and 5th from the bottom). Some examples are included in the **cooking guide** table.

When cooking other food on several racks, use the **roast mode**  keeping the following suggestions in mind:

- The oven is fitted with 5 racks. During fan assisted cooking, use two of the three central racks; the lowest and highest racks receive the hot air directly and therefore delicate foodstuffs could be burnt on these racks.
- As a general rule, use the 2nd and 4th rack from the bottom, placing the foodstuffs that require greater heat on the 2nd rack from the bottom. For example, when cooking meat roasts together with other food, place the roast on the 2nd rack from the bottom and the more delicate food on the 4th rack from the bottom.
- When cooking foodstuffs that require differing times and temperatures, set a temperature that is somewhere between the two temperatures required, place the more delicate food on the 4th rack from the bottom and take the food requiring less time out of the oven first.
- Use the dripping pan on the lower rack and the grid on the upper.

HINTS & TIPS

Using the grill

- This multi-function oven has 3 different grilling modes.
- Use the **grill mode** , **maxi grill mode**  or **fan grill mode**  placing the food under the center of the grill (situated on the 3rd or 4th rack from the bottom) because only the central part of the top heating element is turned on.
- Use the bottom rack (1st from the bottom), placing the dripping pan provided to collect any sauce and /or grease and prevent the same from dripping onto the oven bottom. When using this mode, we recommend you set the thermostat to the highest setting. However, this does not mean you cannot use lower temperatures, simply by adjusting the thermostat knob to the desired temperature.



Using fan grill

- Setting **fan grill mode** , is extremely useful for grilling foods rapidly, as the distribution of heat makes it possible not only to brown the surface, but also to cook the bottom part.
- Moreover, it can also be used for browning foods at the end of the cooking process, such as adding that gratin finish to pasta bakes.
- When using this mode, place the grid on the 2nd or 3rd oven rack from the bottom (see cooking table) then, to prevent fat and grease from dripping onto the bottom of the oven and thus smoke from forming, place a dripping-pan on the 1st rack from the bottom.
- When using this mode, we advise you to set the thermostat to 200°C, as it is the most efficient way to use the grill, which is based on the use of infrared rays. However, this does not mean you cannot use lower temperatures, simply by adjusting the thermostat knob to the desired temperature.

- ① **Important!** Therefore the best results when using the grill modes are obtained by placing the grid on the lower racks (see cooking table) then, to prevent fat and grease from dripping onto the bottom of the oven and smoke from forming, place a dripping-pan on the 1st oven rack from the bottom. Always grill with the oven door closed.

HINTS & TIPS

Using Air Fry

- To use the **Air Fry mode** , put your food on the 3rd oven rack from the bottom. Because the top and circle heating element is turned on, Air fry enables advanced convection cooking function without having to turn the food, giving crispy great tasting results in a shorter time without all the oil. This is suitable for french fries, chicken wings, nuggets and similar products. Put the baking tray on the lowest shelf position to catch any spills. When using **Air Fry mode** , set the temperature to 230°C.

Baking cakes

- When baking cakes, always place them in a preheated oven. Make sure you wait until the oven has been preheated thoroughly (the indicator light will turn off). To prevent heat loss and the cake from dropping, do not open the oven door during baking.
- **In general, if pastry is too dry:** increase the temperature by 10°C and reduce the cooking time.
- **If pastry has dropped:** use less liquid or lower the temperature by 10°C.
- **If pastry is too dark on top:** place it on a lower shelf, lower the temperature, and increase the cooking time.
- **If cooked well on the inside but sticky on the outside:** use less liquid, lower the temperature, and increase the cooking time.
- **If the pastry sticks to the pan:** grease the pan well and sprinkle it with a dusting of flour or use greaseproof paper.
- **If I used multi shelf cooking and one shelf is more cooked:** use a lower temperature setting next time. It is not necessary to remove the food from all the racks at the same time.

HINTS & TIPS

Cooking pizza





- For best results when cooking pizza, use the **pizza mode** .
- Preheat the oven for at least 10 minutes.
- Use a light aluminum pizza pan, placing it on the grid supplied with the oven. Don't use the dripping pan since this will extend the cooking time, making it difficult to get a crispy crust.
- Do not open the oven door frequently while the pizza is cooking;
- If the pizza has a lot of toppings (three or four), we recommend you add the mozzarella cheese on top halfway through the cooking process.
- For best results, only use one shelf at a time, but if you want to cook on two shelves, use the 2nd and 4th racks from the bottom with a temperature of 220°C and swap them halfway through cooking.

Cooking fish and meat

- When cooking white meat and fish, use a temperature setting from 180°C to 200°C.
- For red meat that you want well done on the outside while tender and juicy in the inside, it is best to start with a high temperature setting (200°C-220°C) for a short time, then turn the oven down afterwards.
- In general, the larger the roast, the lower the temperature setting.
- Place the meat on the centre of the shelf and place the dripping pan beneath it to catch the fat.
- Make sure that the shelf is inserted so that it is in the centre of the oven. If you would like to increase the amount of heat from below, use a lower shelf height.



HINTS & TIPS

Cooking Guide

Foods	Weight (kg)	Cooking position*	Preheat time (min)	Temp. setting	Cooking time (min)
 Defrost					
All frozen food					
 Grill /  Maxi grill					
Soles & cuttlefish	1	4	5	Max	8 - 10
Squid & prawn kebabs	1	4	5	Max	6 - 8
Cod fish	1	4	5	Max	10
Grill vegetables	1	3/4	5	Max	10 - 15
Veal steak	1	4	5	Max	15 - 20
Cutlets	1	4	5	Max	15 - 20
Hamburgers	1	4	5	Max	7 - 10
Mackerels	1	4	5	Max	15 - 20
Toasted sandwiches	-	4	5	Max	2 - 3
 Fan grill					
Grilled chicken	1.5	3	5	200	55 - 60
Cuttlefish	1.5	3	5	200	30 - 35
Pizza (on 2 racks)	1	2 - 4	15	220	15 - 20
Lasagna	1	3	10	200	30 - 35
Lamb	1	2	10	180	50 - 60
Roast chicken + potatoes	1	2 - 4	10	180	60 - 75
Mackerel	1	2	10	180	30 - 35
Plum cake	1	2	10	170	40 - 50



*Rack position from the bottom

HINTS & TIPS

Foods	Weight (kg)	Cooking position*	Preheat time (min)	Temp. setting	Cooking time (min)
 Fan grill (continued)					
Cream puffs (on 2 racks)	0.5	2 - 4	10	190	20 - 25
Biscuits (on 2 racks)	0.5	2 - 4	10	180	10 - 15
Sponge cake (1 cake)	0.5	2	10	170	15 - 20
Sponge cake (2 cakes)	1	2 - 4	10	170	20 - 25
Savory pies	1.5		15	200	25 - 30
 Fan forced /  Eco bake					
Tarts	0.5	3	15	180	20 - 30
Fruit cakes	1	2/3	15	180	40 - 45
Fruit cake	0.7	3	15	180	40 - 50
Sponge cake	0.5	3	15	160	25 - 30
Stuffed pancakes (on 2 shelves)	1.2	2 - 4	15	200	30 - 35
Small cakes (on 2 shelves)	0.6	2 - 4	15	190	20 - 25
Cheese puffs (on 2 shelves)	0.4	2 - 4	15	210	15 - 20
Cream puffs (on 3 shelves)	0.7	1 - 3 - 5	15	180	20 - 25
Biscuits (on 3 shelves)	0.7	1 - 3 - 5	15	180	20 - 25
Meringues (on 3 shelves)	0.5	1 - 3 - 5	15	90	180



*Rack position from the bottom

HINTS & TIPS

Foods	Weight (kg)	Cooking position*	Preheat time (min)	Temp. setting	Cooking time (min)
 Roast					
Pizza (on 2 racks)	1	2 - 4	15	220	15 - 20
Lasagna	1	3	10	200	30 - 35
Lamb	1	2	10	180	50 - 60
Roast chicken + potatoes	1	2 - 4	10	180	60 - 75
Mackerel	1	2	10	180	30 - 35
Plum cake	1	2	10	170	40 - 50
Cream puffs (on 2 racks)	0.5	2 - 4	10	190	20 - 25
Biscuits (on 2 racks)	0.5	2 - 4	10	180	10 - 15
Sponge cake (1 cake)	0.5	2	10	170	15 - 20
Sponge cake (2 cakes)	1	2 - 4	10	170	20 - 25
Savory pies	1.5		15	200	25 - 30
 Bake					
Duck	1	3	15	200	65 - 75
Roast veal or beef	1	3	15	200	70 - 75
Pork roast	1	3	15	200	70 - 80
Biscuits (short pastry)	-	3	15	180	15 - 20
Tarts	1	3	15	180	30 - 35

*Rack position from the bottom

HINTS & TIPS

Foods	Weight (kg)	Cooking position*	Preheat time (min)	Temp. setting	Cooking time (min)
 Fan assist					
<i>Frozen food</i>					
Pizza	0.3	2	-	250	12
Courgette & prawn pie	0.4	2	-	200	20
Country style spinach pie	0.5	2	-	220	30 - 35
Turnovers	0.3	2	-	200	25
Lasagne	0.5	2	-	200	35
Golden rolls	0.4	2	-	180	25 - 30
Chicken morsel	0.4	2	-	220	15 - 20
<i>Pre-cooked food</i>					
Golden chicken wings	0.4	2	-	200	20 - 25
<i>Fresh food</i>					
Biscuits (<i>short pastry</i>)	0.3	2	-	200	15 - 18
Fruit cake	0.6	2	-	180	45
Cheese puffs	0.2	2	-	210	10 - 12
 Pizza					
Pizza	0.5	2	15	220	15 - 20
Roast veal or beef	1	2	10	220	25 - 30
Chicken	1	2/3	10	180	60 - 70

*Rack position from the bottom

HINTS & TIPS

Foods	Weight (kg)	Cooking position*	Preheat time (min)	Temp. setting	Cooking time (min)
 Air Fry					
Scotch fillet steak (<i>seared first</i>)	1	3	5	220	8
Frozen chips	1	3	5	220	15
Chicken drumettes / wingettes (<i>with dry rub</i>)	1	3	5	230	15
Fresh barramundi fillet (<i>with crumb</i>)	1	3	5	230	15
Potatoes (<i>cut into wedges</i>)	0.5	3	5	230	14
Frozen food					
Chicken nuggets / crumbed fish	1	3	5	230	15
Smashed chats (<i>parboiled</i>)	1	3	4 - 5	220	15

*Rack position from the bottom

- ① **Note:** Cooking times are approximate and may vary according to personal taste. When cooking using the grill or fan assisted grill, the dripping pan must always be placed on the 1st oven shelf from the bottom.

CLEANING & MAINTENANCE

- Clean the oven thoroughly before using for the first time. Do not use sharp or abrasive cleaning materials. These could damage the oven.
 - Before cleaning your oven or performing maintenance, make sure that the oven is turned **off**. To extend the life of your oven, it must be cleaned frequently.
 - The enamelled or stainless steel parts should be washed with lukewarm water without using any abrasive powders or corrosive substances. If any stainless steel has difficult to remove stains, use cleaners specifically recommended to clean stainless steel. After cleaning any surface, it is advisable to rinse thoroughly and dry.
 - The inside of the oven should preferably be cleaned immediately after use, when it is still warm (but not hot), with warm water and soap. The soap should be rinsed away and the interior dried thoroughly. Avoid using abrasive detergents, scourers acidic cleaners such as lime scale remover, etc. as these could damage the enamel. If stains are particularly tough to remove, use cleaners specifically recommended to clean ovens and follow the instructions provided with the cleaner.
- ① **Important!** Never use a steam cleaner or caustic oven cleaners for cleaning inside the oven.
- If you operate your oven for an extended period of time, or if you are cooking dishes that contain a lot of water, condensation may form on the oven door. Dry it using a soft cloth and try reducing the cooking temperature.
 - There is a seal surrounding the oven opening which is necessary to ensure the correct operation of the oven. Check the condition of this seal on a regular basis. If necessary, clean it but avoid using abrasive products or objects to do so. Should it become damaged, please contact Glen Dimplex Service Department. We recommend you avoid using the oven until it has been repaired.
- ① **Important!** Never place anything (including foil and oven trays) on the bottom of the oven when it is in operation because this could damage the enamel.
- Clean the glass door using non-abrasive products or sponges and dry it with a soft cloth.
- ① **Important!** Do not use harsh abrasive cleaners or sharp metal scrapers to clean the oven door glass since they can scratch the surface, which may result in shattering of the glass. Use only non caustic oven cleaners purchased from hardware stores or supermarkets.

CLEANING & MAINTENANCE

General Oven Cleaning

- ① Open the door, the oven lights comes on by touching the light button .
- ② Clean all oven trays, accessories and side runners with warm water or washing up liquid and polish dry with a soft clean cloth.
- ③ Clean the oven interior with a soft clean cloth.
- ④ Wipe the front of the appliance with a damp cloth.





Check that the clock is set correctly. Remove accessories and operate the oven on the fan forced setting at 200 °C for 1 hour before using. There will be a distinctive odor; this is normal, but ensure your kitchen is well ventilated during this conditioning period.

Steam Assisted Cleaning

This function assists in the removal of food residue from inside the oven.

This method is effective in removing light soiling only. It is not effective in removing stubborn baked-on stains. This function can only be used when the oven is cold.

Procedure for cleaning:

- ① Remove all shelves, dishes and side racks.
- ② Make a solution of water (85%), white vinegar (10%), and dish washing detergent (5%) and spray liberally on to door, side walls and back wall of oven cavity.
- ③ Pour 40ml of water into the cavity base well.
- ④ Close the door. Select **steam assist**  from the **function select menu**  and then use  or  buttons to set the temperature to 130°C.
- ⑤ Turn the oven **off** after 18 minutes.
- ⑥ Allow to cool to a safe level before wiping surface with a damp cloth.

CLEANING & MAINTENANCE



Pyro / Self Cleaning

There are 3 time durations to select depending on the degree of self cleaning required:

Standard	Degree of Self Cleaning	Duration (hours approx.)
1	Light: This is a shorter, energy saving cleaning cycle that can be used on a regular basis when the oven is lightly soiled. Usually after every 2nd or 3rd roast.	2
2	Normal: Use this option as the regular cleaning cycle, about once every 2-3 months.	2.5
3	Heavy: If the oven is very dirty, a longer cleaning cycle may be required to clean it thoroughly. This cycle will help to clean even the dirtiest of ovens.	3

Things to know before using the Pyro Clean function

- For safety reasons, the oven locks automatically when the Pyro function begins.
- You will only be able to open the door again once the temperature has fallen below 250°C. The exterior of the oven will become very hot.
- Make sure that nothing is placed against the front panel.

Keep children at a safe distance

- Never attempt to open the oven during the self cleaning process. The cleaning process may be interrupted.
- Please do not attempt to push in the door locking mechanism by hand.
- You cannot switch the oven light on during self cleaning.

CLEANING & MAINTENANCE





Before self cleaning

- Remove all oven racks, baking trays, telescopic rails and other accessories from the oven. This includes the chrome side racks mounted to the walls of the oven cavity.
- Make sure to remove any loose food residue, grease or meat juices which may be flammable.
- Clean the door and along the edges of the oven around the seal.
Do not scour the seal.
- Make sure that the oven door is closed before you start cleaning.

Cleaning accessories at the same time

- All accessories must be removed from the oven before using the Pyro Clean function, including shelves, trays and side racks. These are not suitable for pyrolytic cleaning.
- Never clean metal sheets and dishes which have been coated with a non stick coating using the oven's automatic self-cleaning function (Pyro function).
- High temperatures can cause poisonous gases to be formed from the non stick coating risking serious damage to your health.

How to Pyro Clean

- ① Select **Pyro Clean**  from the **function select menu** .
- ② Press  or  buttons to select the desired Pyro Cleaning duration.
- ③ Press the start / pause button  to activate the Pyro Clean function. The oven will automatically lock until the cycle is complete and the oven has returned to a safe temperature.

CLEANING & MAINTENANCE

How to Remove the Oven Door

You can remove the oven door for better access to the oven when cleaning. Proceed as follows to remove the door:

- ① Open the door fully.
- ② Lift up and turn the latch **A** situated on each of the two hinges.
- ③ Grip the door on the two external sides and close it approximately 3/4 way.
- ④ Pull the door up towards you, lifting it out of the oven frame.
- ⑤ To replace the door, repeat the above steps in reverse order.

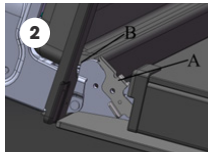

CLEANING & MAINTENANCE

How to Dismantle the Oven Door for Cleaning

You can remove the inner door glass for better cleaning. Proceed as follows to remove the inner door glass:

- ① Remove the cap on top of the door by unscrewing the 2 screws on the left and right sides.
- ② Gently slide out the inner pane of glass.
- ③ Clean the glass with an appropriate cleaner. Dry thoroughly and place on a soft surface.
- ④ Now you can also clean the inside of the outer glass.
- ⑤ Use the reverse procedure to re-assemble the door glass.

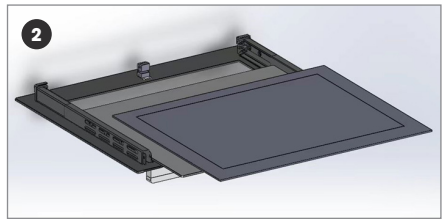
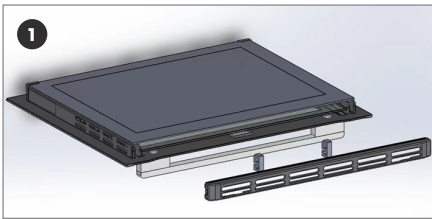

CLEANING & MAINTENANCE

Replacing the Oven Lamps

⚠ **Warning!** Ensure that the appliance is switched off before replacing the lamp to avoid the possibility of electric shock. Remove the glass cover of the lamp-holder.

Remove the lamp and replace with a lamp resistant to high temperatures (300°C) with the following characteristics:

- Voltage: 220-240V
- Wattage: 25W
- Type: G9

① **Note:** Replacement lamps are available from Glen Dimplex.

Replace the glass cover and reconnect the oven to the mains power supply.

Replacing the side lamp

- ① Remove the side racks.
- ② Take off the protective glass cover.
- ③ Pull the light bulb down to remove it.
- ④ After inserting the new bulb, install the glass cover and side racks back to their original position.

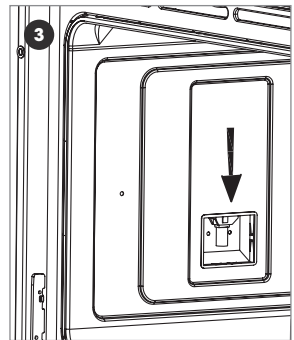
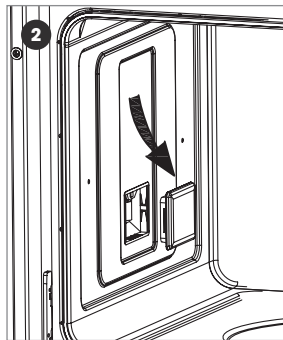
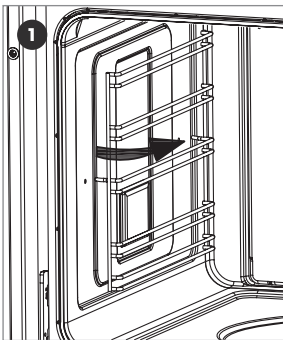
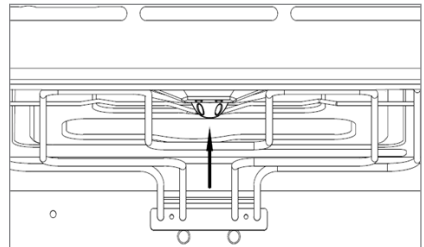

PRODUCT INFORMATION

Model number(s):	EPO917ASTB (Dark stainless steel)
Voltage & frequency:	220 - 240V ~ / 50 - 60Hz
Usable volume:	133L
Total volume:	148L
Output power:	3200 - 3800W
Net weight (kg):	51.0
Gross weight (kg):	57.0
Product dimensions (mm):	894 (w) x 595 (h) x 575.2 (d)
Cut-out dimensions (mm):	900 (w) x 600 (h) x 580 (d)

MANUFACTURER GUARANTEE

This warranty is provided in Australia by Glen Dimplex Australia Pty Limited ABN 69 118 275 460 (**Phone number 1300 556 816**) and in New Zealand by Glen Dimplex New Zealand Limited NZBN 9429000069823 (**Phone number 09 274 8265**) in respect of the Euromaid product.

1. Euromaid Express Warranty

Subject to the exclusions below, we warrant that the product will not have any electrical or mechanical breakdowns within:

- Ⓐ In the case of **Euromaid** products used for personal, domestic or household purposes, a period of **2 years** from the date the product is purchased as a brand-new product from a retailer located in Australia / New Zealand.
- Ⓑ The warranty period may be extended by an additional **3 years** (5 years total) if the appliance is registered on the **Euromaid** website (listed below) within 90 days following the date of original purchase.
Australia: euromaid.com.au **New Zealand:** euromaid.co.nz
- Ⓒ In the case of **Euromaid** products used for purposes other than personal, domestic or household purposes (including business or commercial use), a period of 90 days from the date the product is purchased as a brand-new product from a retailer located in Australia / New Zealand. **Euromaid** products are designed and intended for domestic use only; and
- Ⓓ All warranty repairs must be carried out by Glen Dimplex or their nominated service agent.
- Ⓘ **Note: warranty periods detailed above may vary in line with agreements with select retail and builder partners and may differ between Australia and New Zealand.**

The benefits conferred by this express warranty are in addition to the Consumer Guarantees referred to in section 3 and any other statutory rights you may have under the Australian / New Zealand Consumer Law and/or other applicable laws.

MANUFACTURER GUARANTEE

2. Warranty Exclusions

This express warranty does not apply where:

- Ⓐ The product has been installed, used or operated otherwise than in accordance with the product manual or other similar documentation provided to you with the product;
- Ⓑ The product requires repairs due to damage resulting from accident, misuse, incorrect installation, insect or vermin infestation, improper liquid spillage, cleaning or maintenance, unauthorised modification, use on an incorrect voltage, power surges and dips, voltage supply problems, tampering or unauthorised repairs by any persons, use of defective or incompatible accessories or exposure to abnormally corrosive conditions, events independent of human control which occurred after the goods left the control of Glen Dimplex;
- Ⓒ The repair relates to the replacement of consumable parts such as fuses and bulbs or any other parts of the product which require routine replacement;
- Ⓓ You are unable to provide us with reasonable proof of purchase for the product;
- Ⓔ The breakdown occurs after the expiry of the express warranty period set out in section 1 or;
- Ⓕ The product was not purchased in Australia / New Zealand as a brand-new product.

3. Consumer Guarantees

Our goods come with guarantees that cannot be excluded under the Australian / New Zealand Consumer Law. You are entitled to a replacement or refund for a major failure and for compensation for any other reasonably foreseeable loss or damage. You are also entitled to have the goods repaired or replaced if the goods fail to be of acceptable quality and the failure does not amount to a major failure.

MANUFACTURER GUARANTEE

4. How to Make a Claim

You may make a claim under this warranty through our website, contacting our customer care line or via email. Contact details for Glen Dimplex Australia and New Zealand can be found at the end of this document.

To make a valid claim under this warranty, you must:

- Ⓐ Lodge the claim with us as soon as possible and no later than 14 days after you first become aware of the breakdown;
- Ⓑ Provide us with the product serial number;
- Ⓒ Provide us with reasonable proof of purchase for the product. This can take the form of a store receipt, new home handover form or other payment receipt documentation; and
- Ⓓ If required by us, provide us (or any person nominated by us) with access to the premises at which the product is located at times nominated by us (so that we can inspect the product).

5. Warranty Claims

If you make a valid claim under this warranty and none of the exclusions set out in section 2 apply, we will, at our election, either repair the product or replace the product with a product of identical specification (or where the product is superseded or no longer in stock, with a product of as close a specification as possible).

Goods presented for repair may be replaced by refurbished goods of the same type rather than being repaired. Refurbished parts may be used to repair the goods. Products are designed and supplied for normal domestic use. We will not be liable to you under this warranty for business loss or damage of any kind whatsoever.

Contact our Customer Care Team

Glen Dimplex Australia Pty Ltd

Ph: 1300 556 816
customer.care.ha@glendimplex.com.au
www.glendimplex.com.au

Glen Dimplex New Zealand Ltd

Ph: 09 274 8265
nztechserv@glendimplex.co.nz
www.glendimplex.co.nz

NOTES

READ THE INSTRUCTION BOOKLET BEFORE INSTALLING & USING THE APPLIANCE.

The manufacturer will not be responsible for any damage to property or to persons caused by incorrect installation or improper use of the appliance. The manufacturer is not responsible for any inaccuracies, due to printing or transcription errors, contained in this manual. In addition, the appearance of the figures reported is also purely indicative.

The manufacturer reserves the right to make changes to its products when considered necessary and useful, without affecting the essential safety and operating characteristics. Glen Dimplex constantly seeks ways to improve the specifications and designs of their products. Whilst every effort is made to produce up to date literature, this document should not be regarded as an infallible guide. Actual product only should be used to derive cut out sizes.

All appliances must be installed by a qualified person/s with adherence to the relevant electrical, plumbing and building codes, with compliance being issued as required by state or national legislation.

Additionally, all upright cookers must have the anti-tilt device installed correctly in adherence to the relevant standards by a licenced installer.

For maximum effectiveness and efficiency all rangehoods should be installed with the use of ductwork, by a licenced installer with adherence to the relevant state and national building codes and regulations.

All Glen Dimplex appliances are for Domestic use only, and must be installed by a licenced installer into Domestic Applications only, without exception and to the required Authorities guidelines. Any installation outside of this will **VOID** warranty. Alfresco areas are not a Domestic application.

Euromaid

Distributed by

Glen Dimplex Australia Pty Ltd

Ph: 1300 556 816
customer.care.ha@glendimplex.com.au
www.glendimplex.com.au

Glen Dimplex New Zealand Ltd

Ph: 09 274 8265
nztechserv@glendimplex.co.nz
www.glendimplex.co.nz

*For service advice, please contact the Customer Care Centre by phone or email above.
For full terms and conditions, or to register your product warranty, please visit our website.*

Euromaid

euromaid.com.au | euromaid.co.nz